

Data Sheet



Article number: 604132040085

Description: Taper bored timing belt pulley
HTD 40 8M 85 TL 2012

Measures

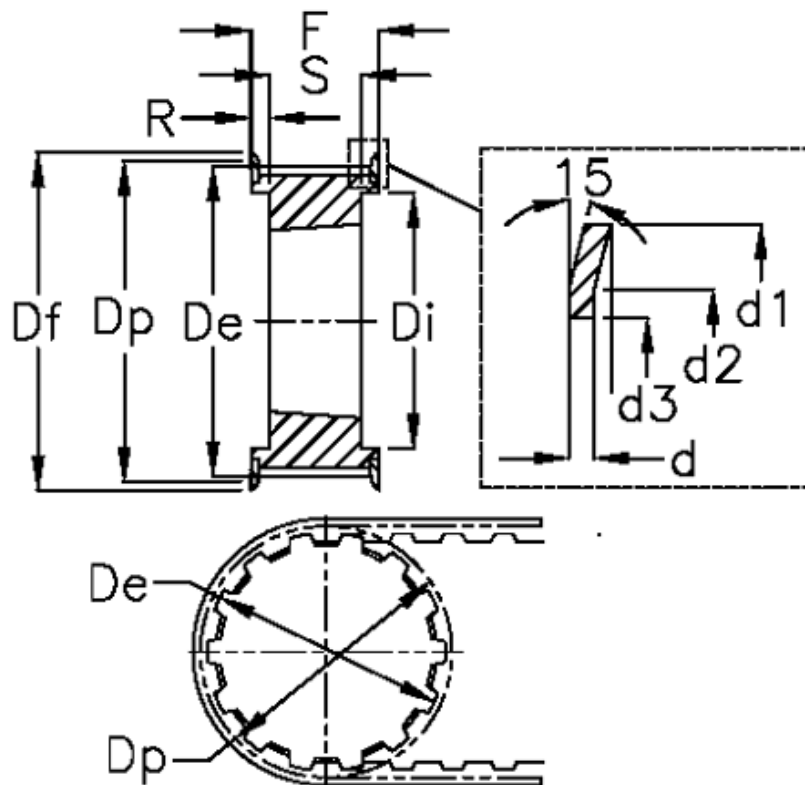

d = 1.5	F = 95	Weight = 1.8
d1 = 106	Flange type = F35	Width = 85
d2 = 101	For bushing = 2012	
d3 = 90	Max bore = 50	
De = 100.49	r = 31.5	
Df = 106	S = 32	
Di = 82	Tooth number = 40	
Dp = 101.86	Type = 8M	